









DOOR REINFORCERS

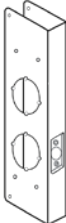
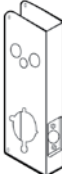



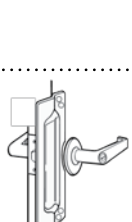



Application	Part No.	Finish	Overall Size	Back Set	Door Thickness	List	
For Cylindrical Door Locks with 2 1/8" hole, 9" height.	2-PB-CW	605	4" x 9"	2 3/8"	1 3/4"	22.95	
	2-S-CW	630				22.15	
	3-BZ-CW	612	4 1/4" x 9"	2 3/4"	1 3/8"	31.05	
	3-PB-CW	605				22.95	
	3-S-CW	630				22.15	
		4-BZ-CW	612	4 1/4" x 9"	2 3/4"	1 3/4"	31.05
		4-S-CW	630				22.15
For Cylindrical Door Locks with 2 1/8" hole, 4 1/2" height.	61-PB-CW	605	4" x 4 1/2"	2 3/8"	1 3/4"	14.50	
	81-BZ-CW	612	4 1/4" x 4 1/2"	2 3/4"	1 3/4"	21.95	
	81-S-CW	630				14.15	
For Cylindrical Door Locks with 2 1/8" hole, 12" height.	12-S-CW	630	4 1/4" x 12"	2 3/4"	1 3/4"	26.05	
Blank Wrap-Around.	20B-S-CW	630	5" x 20"	—	1 3/4"	42.85	
	40-S-CW	630	4 1/4" x 9"	—	1 3/4"	22.15	
	80-BZ-CW	612	4 1/4" x 4 1/2"	—	1 3/4"	21.95	
	80-S-CW	630				14.15	
	90-S-CW	630	5" x 12"	—	1 3/4"	26.05	
For ADA Lever Locks with 2 1/8" Bore. For Best 93K Lever Lock & 73K Lockset, Sargent 6500 Series.	5K-S-CW	630	4 3/4" x 5 1/2"	2 3/4"	1 3/4"	16.95	
	9K-S-CW	630	4 3/4" x 9"	2 3/4"	1 3/4"	25.95	
For use with Heavy Duty key-in-lever 2 1/8" hole. For Schlage Rhodes, Arrow Sierra, Corbin Russwin 3300 & 3600, Sargent 10-Line, Yale 5400LN and Falcon T & B series.	4-BZ-2-CW	612	4 3/4" x 9"	2 3/4"	1 3/4"	32.85	
	4-S-2-CW	630				25.95	
	81-S-2-CW	630	4 3/4" x 4 1/2"	2 3/4"	1 3/4"	16.95	
For use with Kaba-Ilco Simplex Uni-can 1000 series.	9-S-CW	630	5" x 9"	2 3/4"	1 3/4"	27.15	
	15-AB-CW	609	5" x 15"	2 3/4"	1 3/4"	57.25	
	15-PB-CW	605				42.85	
	15-S-CW	630				39.20	









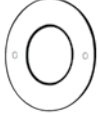

DOOR REINFORCERS (cont.)							
Application		Part No.	Finish	Overall Size	Back Set	Door Thickness	List
For Kaba-Ilco Simplex Unican 4000 series.		4000-4-CW	630	5" x 15"	2 ³ / ₄ "	1 ³ / ₄ "	39.20
For Alarm Lock T2 / DL2700 and 3000 series Trilogy Lock.		27-PB-CW	605	5" x 15"	2 ³ / ₄ "	1 ³ / ₄ "	42.85
		27-S-CW	630				39.20
For KABA-MAS (Mas-Hamilton) Power Lever Series.		16-S-CW	630	5" x 15"	2 ³ / ₄ "	1 ³ / ₄ "	39.20
For BEST 93-KV Series Locks.		93-KV-S-CW	630	5 ¹ / ₂ " x 12 ³ / ₄ "	2 ³ / ₄ "	1 ³ / ₄ "	60.00
For conversion of KABA-ILCO Simplex Unican & Alarm Lock DL2500, 2700T2 & 3000 series to key-in-knob lock.		14-PB-CW	605	5" x 14"	2 ³ / ₄ "	1 ³ / ₄ "	37.35
		14-S-CW	630				32.50
For conversion of KABA-ILCO Simplex Unican & Alarm Lock DL2500, 2700T2 & 3000 series to key-in-knob lock.		14-PB-2-CW	605	5" x 14"	2 ³ / ₄ "	1 ³ / ₄ "	39.95
		14-S-2-CW	630				37.95

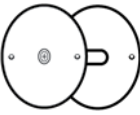
DOOR REINFORCERS (cont.)							
Application		Part No.	Finish	Overall Size	Back Set	Door Thickness	List
Mortise Lock wrap-around plate for 86 cut-out.		504-BZ-CW	612	5" x 12"	—	1 ³ / ₄ "	93.25
		504-S-CW	630				29.00
Mortise Lock wrap-around plate for 86 cut-out.		514-BZ-CW	612	5" x 12"	2 ³ / ₄ "	1 ³ / ₄ "	93.25
		514-S-CW	630				29.00

LATCH GUARDS					
Description		Part No.	Finish	Size (w x h)	List
Interlock, 6" for inswinging doors. All Backsets, Deadbolts and Key-in-Knob/Lever Locks. Reinforces Door and Frame, Prevents Spreading of Frame, Hardened Concealed Screws. 14GA.		ILP-206 BP	Brass Plated	5/8" x 6"	15.00
		ILP-206 SL	Silver Coated		14.00
Interlock, 12" for inswinging doors. All Backsets, Double Locks, Mortise Locks & Access Control Locks. Reinforces Door and Frame, Prevents Spreading of Frame, Hardened Concealed Screws. 14GA		ILP-212 BP	Brass Plated	5/8" x 12"	16.00
		ILP-212 SL	Silver Coated		15.50
Latch Protector 11" for Outswinging Doors. All Backsets, Key-in-Lever Locks and Key-in-Knob Locks. Reinforces Door and Frame, Furnished with carriage bolts, washers & acorn cap nuts. 12GA.		LP-111 630	Stainless	3" x 11"	20.85
		LP-211 SL	Silver Coated	3" x 11"	12.10
Latch Protector w/ Pin for Outswinging Doors. All Backsets, Key-in-Lever Locks and Key-in-Knob Locks. Solid steel pin prevents spreading of frame, Reinforces Door and Frame, Prevents Spreading of Frame, Furnished with carriage bolts, washers & acorn cap nuts. 12GA.		PLP-111 630	Stainless Steel	3" x 11"	21.80
Latch Protector w/ Pin for Outswinging Doors. Mortise Locks. Solid steel pin prevents spreading of frame, Reinforces Door and Frame, Prevents Spreading of Frame, Furnished with carriage bolts, washers & acorn cap nuts. 12GA.		PMLP-211 SL	Silver Coated	3" x 11"	11.10
Latch Protector 7" for Outswinging Doors. All Backsets, Key-in-Lever Locks and Key-in-Knob Locks. Reinforces Door and Frame, Furnished with carriage bolts, washers & acorn cap nuts. 12GA.		LP-107 630	Stainless	3" x 7"	26.20
		LP-207 BP	Brass Plated	3" x 7"	13.75
		LP-207 DU	Duro Coated	3" x 7"	11.15
Angle Type Latch Guard 6" for Out-Opening Doors. For Mortise or Key-in-Knob Locks. 10GA.		ALP-206 SL	Silver Coated	6"	13.40
Latch Guard for Electric Strike for Out-Opening Doors. 12GA.		ELP-208 SL	Silver Coated	3 1/2" x 8"	22.95
Latch Guard 6" for Out-Opening Doors. For Key-in-Knob Locks. Accepts up to 3 3/4" Rose. Furnished with carriage bolts, washers & acorn cap nuts. 12GA.		SLP-206 SL	Silver Coated	2 1/2" x 6"	12.35



LATCH GUARDS (cont.)					
Description		Part No.	Finish	Size (w x h)	List
Latch Protector for Out-Opening Doors. Fits Adams Rite latch lock. 12GA. 1/4" offset x 17/16" hole x 1 1/8" backset		LP-312 SL	Silver Coated	2 5/8" x 12"	15.50
		LP-312 DU	Duro Coated		

STRIKES					
Description		Part No.	Finish	Overall Size	List
Security Deadbolt Strike with 3" Screws to Secure Strike. 13 GA. (CARDED)		2-SDS BP	Brass Plated	1 1/4" x 4 7/8"	6.45
		2-SDS SL	Silver Coated		
Heavy Gauge Strike single hole version 13 GA. (POLYBAGGED)		FL-208N BP	Brass Plated	1 3/8" x 8"	13.70
		FL-208N SL	Silver Coated		
Heavy Gauge Strike double hole version 4" center holes 13 GA. (CARDED)		FL-212W4 BP	Brass Plated	1 3/4" x 12"	17.25
		FL-212W4 SL	Silver Coated		
Heavy Gauge Strike double hole version 6" center holes 13 GA. (POLYBAGGED)		FL-212W6 BP	Brass Plated	1 3/4" x 12"	17.25
		FL-212W6 SL	Silver Coated		
Replacement Lip Strike 2 1/4" x 1 1/4". 18GA. (POLYBAGGED - EACH)		ST-214 630	Stainless Steel	1 1/4" x 2 1/4"	2.10
Replacement T-Strike 2 3/4" x 1 1/8". 18GA. (CARDED)		TS-234 605	Brass	1 1/8" x 2 3/4"	4.25
		TS-234 630	Stainless Steel		3.85
Standard ASA Strike 1 1/4" x 4 7/8" (POLYBAGGED) 13 GA.		ST-261 BP	Brass Plated	1 1/4" x 4 7/8"	6.05
		ST-261 SL	Silver Coated		6.50
4-7/8" Extended Lip Strike		EST-158 630	Stainless Steel	1 5/8" x 4 7/8"	17.50
ASA Mortise Strike 1 1/4" x 4 7/8". 13GA. (POLYBAGGED - EACH)		MST-261 BP	Brass Plated	1 1/4" x 4 7/8"	5.65
		MST-261 SL	Silver Coated		5.15
Thimble Strike 1" Dia. (POLYBAGGED - EACH)		TS-100 BP	Brass Plated	1"	3.20
		TS-100 CP	Chrome Plated		

FILLER PLATES					
Description		Part No.	Finish	List	
Scar Cover Plates, 3 1/2" Diameter for 2 1/8" Bore Locks. Covers Damaged Door, Changes 2 3/8" to 2 3/4" Backset, Changes 2 3/4" to 2 3/8" Backset.		SP-135 605	Brass	4.15	
		SP-135 630	Stainless	3.95	
Cylinder Plate, 2 5/8" Diameter Covers 1 1/2" to 2 1/8" Holes. Indents at 3 & 9 o'clock prevents collar from shifting on wood or metal doors.		CP-258 BP	Brass Plated	3.95	
		CP-258 SL	Silver Coated	3.45	
Hole Filler Plate, 1 7/8" Diameter Covers 1 1/2" Hole. Individually polybagged with screw.		BF-178 BP	Brass Plated	6.55	
		BF-178 SL	Silver Coated	5.20	
		BF-178 PC	Prime Coat	3.55	
Hole Filler Plate, 2 5/8" Diameter Covers 2 1/8" Hole. Individually polybagged with screw.		BF-161 BP	Brass Plated	6.90	
		BF-161 SL	Silver Coated	5.10	
		BF-161 PC	Prime Coat	6.10	
Hole Cover for 2 1/8" Diameter Holes Fits Under Rim Panic Hardware.		PDF-161 PC	Prime Coat	5.40	
Hinge Shim (EACH)		.060 Thick >	HS-060 PC	Prime Coat	1.70
		.090 Thick >	HS-090 PC	Prime Coat	
Filler Plate, 2 3/4" x 1 3/8" T-strike for 160 Cut-Out. Individually polybagged with screws (EACH)		BTS-160 PC	Prime Coat	2.15	
Filler Plate, 4 7/8" x 1 1/4" ANSI for 161 Cut-Out. Individually polybagged with screws (EACH)		FS-260 PC	Prime Coat	2.40	
Filler Plate, 4 1/2" x 1 5/8" Frame Hinge Cut Out. Individually polybagged with screws (EACH)		FF-45	Prime Coat	2.80	
Filler Plate, 4 1/2" x 1 3/4" Door Hinge Cut Out. Individually polybagged with screws (EACH)		HF-45	Prime Coat	3.30	
Filler Plate, 4 1/2" x 1 1/2" Door Hinge Cut Out. Individually polybagged with screws (EACH)		SHF-45	Prime Coat	3.70	

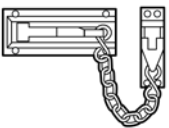
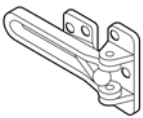
FILLER PLATES (cont.)				
Description		Part No.	Finish	List
Filler Plate, 2¹/₄" × 1" Individually polybagged with screws. (EACH)		EF-160 PC	Prime Coat	2.00
Filler Plate, 2¹/₄" × 1¹/₈" Individually polybagged with screws. (EACH)		EF-161 PC	Prime Coat	2.00
Filler Plate, 2³/₄" × 1¹/₈" Individually polybagged with screws. (EACH)		EF-161-S PC	Prime Coat	2.90
Filler Plate, 6³/₄" × 1" Flush Bolt Cut Out. Individually polybagged with screws. (EACH)		EF-634 PC	Prime Coat	3.15
Filler Plate, 8" × 1¹/₄" Individually polybagged with screws. (EACH)		EF-86 PC	Prime Coat	4.15
Filler Plate, 8" × 1¹/₄" Use with pair of 86 cut out doors. Apply ANSI strike over. Reversible. Individually polybagged with screws. (EACH)		ST-386 PC	Prime Coat	7.60
Converts 86 Cut-Out to 161 Prep, 8" × 1¹/₄" Individually polybagged with screws. (EACH)		CV-86	Prime Coat	9.95
Aluminum Frame Filler Plate, 4⁷/₈" × 1¹/₄" Individually polybagged with screws (EACH)		AF-260 SL	Silver Coated	7.25
Aluminum Frame Filler Plate, 4⁷/₈" × 1¹/₄" Individually polybagged with screws (EACH)		AF-261 SL	Silver Coated	8.95

CHAIN AND FLIP BAR DOOR GUARDS				
Description		Part No.	Finish	List
Chain Guard for Wood or Metal Doors. (CARDED)		1607 605	Brass	9.90
Flip Bar Door Guard for Wood or Metal Doors. (CARDED)		1603 605	Brass	9.95
		1603 625	Chrome	

DOOR VIEWERS				
Description		Part No.	Finish	List
Door Viewer, 160° Solid Brass with Optical Glass Lens. Fits 1 ³ / ₈ " to 2" Doors. 1/2" Installation Hole Diameter. (CARDED)		ULDV-90	Brass	6.65
Door Viewer, Wide Angle, 190° Solid Brass with Optical Glass Lens. Fits 1 ³ / ₈ " to 2" Doors. 9/16" Installation Hole Diameter. (CARDED)		ULDV-180 605	Brass	11.35
		ULDV-180 626	Chrome	

MOUNTING TAB				
Description		Part No.	Finish	List
TAB Steel 1/8" offset, Dimensions 1" x 1 1/2", 13GA .095		TB-215	raw steel	3.80